

## Multi-pole Power Relay for Contactor Current Range Capable of Carrying and Switching 40 A at 440 VAC



- One pole, 40 A can be carried and switched.
- The maximum load capacity of 160 A when using 4-pole parallel connections.
- All materials used are compliant with the RoHS Directive
- EN 60947-4-1 certification for mirror contact mechanisms has been obtained by using a combination of the relay and auxiliary contact blocks.
- A design with a small number of openings makes it difficult for dust or foreign matter to enter.
- Ideal for supply power to industrial inverters, servo drivers, and other devices, and switching power to motors and other equipment.
- Conforms to European PV standard (VDE0126).



Be sure to read the "Safety Precautions" on page 6 and the "Precautions for All Relays with Forcibly Guided Contacts".

For the most recent information on models that have been certified for safety standards, refer to your OMRON website.

## Model Number Structure

### Model Number Legend

#### Relay with Auxiliary Contact Block

G7Z- -    
1 2 3

- 1. Relay Contact Configuration**  
 4A: 4PST-NO  
 3A1B: 3PST-NO/SPST-NC  
 2A2B: DPST-NO/DPST-NC
- 2. Contact Configuration of Auxiliary Contacts**  
 20: DPST-NO  
 11: SPST-NO/SPST-NC  
 02: DPST-NC
- 3. Contact Mechanism of Auxiliary Contacts**  
 Z: Bifurcated crossbar contact

#### Relay

G7Z-   
1

- 1. Contact Configuration**  
 4A: 4PST-NO  
 3A1B: 3PST-NO/SPST-NC  
 2A2B: DPST-NO/DPST-NC

#### Auxiliary Contact Block

G73Z-    
1 2

- 1. Contact Configuration of Auxiliary Contacts**  
 20: DPST-NO  
 11: SPST-NO/SPST-NC  
 02: DPST-NC
- 2. Contact Mechanism of Auxiliary Contacts**  
 Z: Bifurcated crossbar contact

## Ordering Information

### Relay with Auxiliary Contact Block

#### Relay with Auxiliary Contact Block (for Screw Terminals)

Structure		Contact configuration		Rated Voltage	Model
		Relay	Auxiliary Contact Block		
Relay with Auxiliary Contact Block	4 poles + 2 poles	4PST-NO	DPST-NO	12, 24 VDC	G7Z-4A-20Z
			SPST-NO/SPST-NC		G7Z-4A-11Z
			DPST-NC		G7Z-4A-02Z
		3PST-NO/SPST-NC	DPST-NO		G7Z-3A1B-20Z
			SPST-NO/SPST-NC		G7Z-3A1B-11Z
			DPST-NC		G7Z-3A1B-02Z
	DPST-NO/DPST-NC	DPST-NO	G7Z-2A2B-20Z		
		SPST-NO/SPST-NC	G7Z-2A2B-11Z		
		DPST-NC	G7Z-2A2B-02Z		

- Note:**
1. Relay contact terminals are M5, and the coil terminals are M3.5.
  2. Auxiliary contact block terminals are M3.5.
  3. When placing an order, specify the model number and rated supply voltage (12 VDC or 24 VDC).

## Relay

Classification		Structure	Contact configuration	Rated Voltage	Model
Relay	4 poles		4PST-NO	12, 24 VDC	G7Z-4A
			3PST-NO/SPST-NC		G7Z-3A1B
			DPST-NO/DPST-NC		G7Z-2A2B

- Note:** 1. Relay contact terminals are M5, and the coil terminals are M3.5.  
2. When placing an order, specify the model number and rated supply voltage (12 VDC or 24 VDC).

## Accessories (Order Separately)

### Auxiliary Contact Block

Classification	Structure	Contact Configuration	Model
Auxiliary Contact Block	2 poles	DPST-NO	G73Z-20Z
		SPST-NO/SPST-NC	G73Z-11Z
		DPST-NC	G73Z-02Z

## Specifications

### Ratings

#### Coil

Item	Rated current (mA)	Coil resistance ( $\Omega$ )	Must operate voltage	Must release voltage	Maximum voltage	Power consumption (W)
			Percentage of rated voltage			
12 VDC	308	39	75% max.	10% min.	110%	Approx. 3.7
24 VDC	154	156				

- Note:** 1. Rated current and coil resistance were measured at a coil temperature of 23°C with coil resistance of  $\pm 15\%$ .  
2. Operating characteristics were measured at a coil temperature of 23°C.  
3. The maximum allowable voltage is the maximum value of the fluctuation range for the Relay coil operating power supply and was measured at an ambient temperature of 23°C.  
There is, however, no continuous allowance.

### Contacts

#### Relay

Item	Model	G7Z-4A-□Z, G7Z-3A1B-□Z, G7Z-2A2B-□Z		
		Resistive load	Inductive load $\cos\phi = 0.3$	Resistive load L/R = 1 ms
Contact structure		Double break		
Contact material		Ag alloy		
Rated load	NO	40 A at 440 VAC	22 A at 440 VAC	5 A at 110 VDC
	NC	25 A at 440 VAC	10 A at 440 VAC	5 A at 110 VDC
Rated carry current	NO	40 A *		
	NC	25 A		
Maximum contact voltage		480 VAC		125 VDC
Maximum contact current	NO	40 A	22 A	5 A
	NC	25 A	10 A	5 A
Maximum switching capacity	NO	17,600 VA	9,680 VA	550 W
	NC	11,000 VA	4,400 VA	550 W
Failure rate P value (reference value)		2 A at 24 VDC		

**Note:** The ratings for the auxiliary contact block mounted on the G7Z are the same as those for the G73Z auxiliary contact block.

\* Set of Relay and Auxiliary Contact Block: 45 to 60°C; for the continuous carry current, reduce 40 A by 0.7 A/°C.

#### Auxiliary Contact Block

Item	Model	G73Z-20Z, G73Z-11Z, G73Z-02Z		
		Resistive load	Inductive load $\cos\phi = 0.3$	Resistive load L/R = 1 ms
Contact structure		Double break		
Contact material		Au clad + Ag		
Rated load		1 A at 440 VAC	0.5 A at 440 VAC	0.5 A at 110 VDC
Rated carry current		1 A		
Maximum contact voltage		480 VAC		125 VDC
Maximum contact current		1 A	0.5 A	
Maximum switching capacity		440 VA	220 VA	55 W
Failure rate P value (reference value)		1 mA at 5 VDC		

## Characteristics

Item	Classification Model	Relay *5	Auxiliary contact block
		G7Z-4A-□□, G7Z-3A1B-□□Z, G7Z-2A2B-□□Z	G73Z-20Z, G73Z-11Z, G73Z-02Z
Contact resistance *1		400 mΩ max.	100 mΩ max.
Operating time *2		50 ms max.	
Release time *2		50 ms max.	
Maximum operating frequency	Mechanical	1,800 operations/h	
	Rated load	1,200 operations/h	
Insulation resistance *3		1,000 MΩ min.	
Dielectric strength	Between coil and contacts	4,000 VAC, 50/60 Hz for 1 min	---
	Between contacts of different polarity	4,000 VAC, 50/60 Hz for 1 min	
	Between contacts of the same polarity	2,000 VAC, 50/60 Hz for 1 min	
Impulse withstand voltage	Between coil and contacts	10 kV, 1.2 × 50 μs	---
	Between contacts of different polarity	10 kV, 1.2 × 50 μs	
	Between contacts of the same polarity	4.5 kV, 1.2 × 50 μs	
Vibration resistance	Destruction	10 to 55 to 10 Hz, 0.5-mm single amplitude (1.0-mm double amplitude)	
	Malfunction	NO: 10 to 55 to 10 Hz, 0.5-mm single amplitude (1.0-mm double amplitude) NC: 10 to 32 to 10 Hz, 0.5-mm single amplitude (1.0-mm double amplitude)	
Shock resistance	Destruction	Screw mounting: 700 m/s <sup>2</sup> , DIN Track mounting: 500 m/s <sup>2</sup>	
	Malfunction	NO: 100 m/s <sup>2</sup> NC: 25 m/s <sup>2</sup>	
Durability	Mechanical	1,000,000 operations min. (at 1,800 operations/h, contact no load)	
	Electrical *4	AC resistive load: 80,000 operations AC inductive load: 80,000 operations DC resistive load: 100,000 operations (at 1,200 operations/h, rated load)	
Failure rate (P level) (reference value) *6		2 A at 24 VDC	1 mA at 5 VDC
Ambient operating temperature		-25 to 60°C (with no icing or condensation)	
Ambient operating humidity		5% to 85%	
Weight		Approx. 330 g	Approx. 18 g

**Note:** The above values are initial values.

\*1. The contact resistance for the Relay (G7Z) was measured with 1 A at 5 VDC using the voltage drop method.

The contact resistance for the auxiliary contact block (G73Z) was measured with 0.1 A at 5 VDC using the voltage drop method.

\*2. The operate time was measured with the rated voltage imposed with any contact bounce ignored at the ambient temperature of 23°C.

\*3. The insulation resistance was measured with a 1,000-VDC megohmmeter applied to the same places as those used for checking the dielectric strength.

\*4. The electrical endurance was measured at an ambient temperature of 23°C.

\*5. The specifications for the auxiliary contact block mounted on the G7Z are the same as those for the G73Z auxiliary contact block.

\*6. The failure rate is based on an operating frequency of 1,800 operations/h.

## Approved Standards

### UL Standard: UL508, UL840 (File No. E41643)

Model	Coil ratings	Contact ratings	Number of test operations	
G7Z	12, 24 VDC	NO contact	40 A, 480 VAC, 60 Hz (Resistive)	80,000
			5 A, 120 VDC (Resistive)	100,000
			22 A, 480 VAC, 60 Hz (General Use)	100,000
		NC contact	D300* (1-A current applied)	---
			25 A, 480 VAC, 60 Hz (Resistive)	100,000
			5 A, 120 VDC (Resistive)	
10 A, 480 VAC, 60 Hz (General Use)				
D300* (1-A current applied)	---			

\* Auxiliary contact ratings

Model	Contact ratings
G73Z	NO contact NC contact
	D300 (1-A current applied)

### CSA Standard: CSA Certification by

UL US : CSA C22.2 No. 14

CCC Certification (File No.2009010304361493)

GB14048.4 (CCC)

EN Standard/TÜV Certification: EN 60947-4-1

(Certification No. R50079155) (TUV)

Model	Coil ratings	Contact ratings
G7Z	12, 24 VDC	NO contact AC-1: 40 A, 440 V, 50/60 Hz AC-3: 16 A, 440 V, 50/60 Hz DC-1: 5 A, 110 V *AC-15: 0.5 A, 440 V, 50/60 Hz *DC-13: 0.5 A, 110 V
		NC contact AC-1: 25 A, 440 V, 50/60 Hz DC-1: 5 A, 110 V *AC-15: 0.5 A, 440 V, 50/60 Hz *DC-13: 0.5 A, 110 V
G73Z	---	NO contact AC-15: 0.5 A, 440 V, 50/60 Hz DC-13: 0.5 A, 110 V
		NC contact

\* Auxiliary contact ratings

### < Reference > Information

UL 508: Industrial control devices

UL 840: Insulation coordination including clearance and creepage distance for electrical devices

CSA C22.2 No. 14: Industrial control devices

EN 60947-4-1: Contactors

# Dimensions

## Dimensions

### Relay (12 VDC, 24 VDC) with Auxiliary Contact Block

4 Poles

Mounting Hole Dimensions

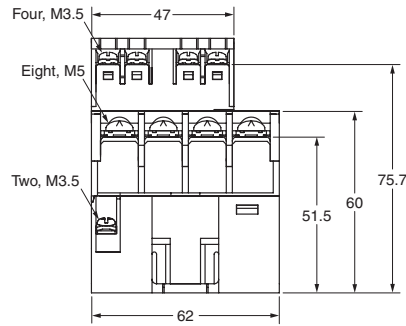
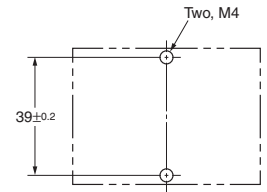
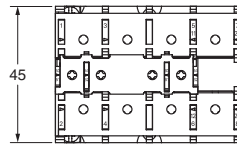
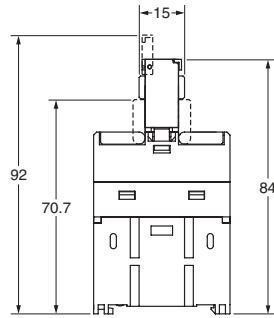

Note: The dimensions are typical values.

### Relay (12 VDC, 24 VDC)

4 Poles

Mounting Hole Dimensions

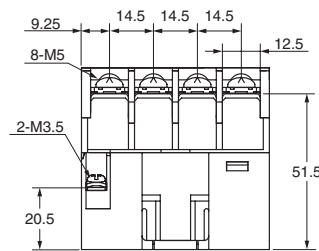
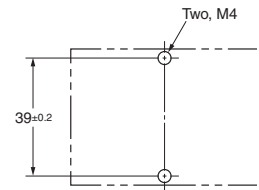
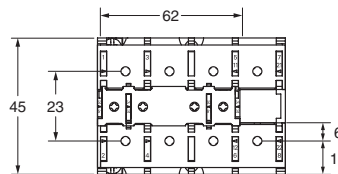
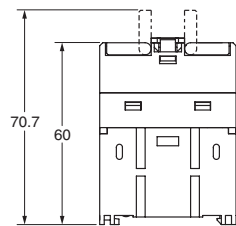

Note: The dimensions are typical values.

### Contact Block

### Auxiliary DIN Track Mounting Height (when using the PFP-100N or PFP-50N mounting rail)

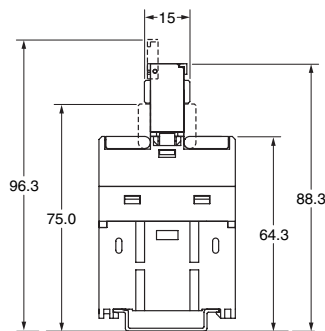
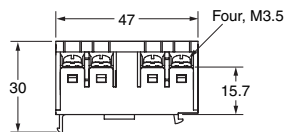
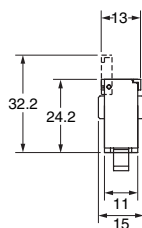

Note: The dimensions are typical values.

Note: The dimensions are typical values.

## Terminal Arrangement/Internal Connections

### Relay with Auxiliary Contact Block

G7Z-4A-20Z

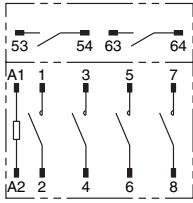

Note: The coil has no polarity.

G7Z-4A-11Z

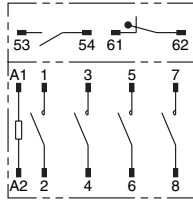

Note: The coil has no polarity.

G7Z-4A-02Z

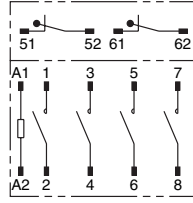

Note: The coil has no polarity.

G7Z-3A1B-20Z

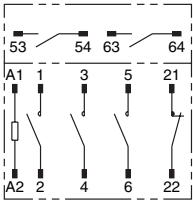

Note: The coil has no polarity.

G7Z-3A1B-11Z

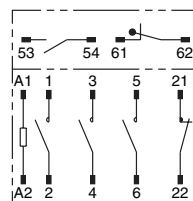

Note: The coil has no polarity.

G7Z-3A1B-02Z

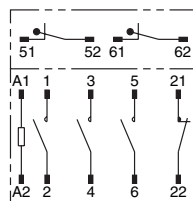

Note: The coil has no polarity.

G7Z-2A2B-20Z

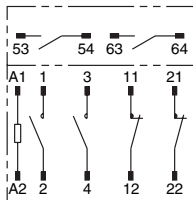

Note: The coil has no polarity.

G7Z-2A2B-11Z

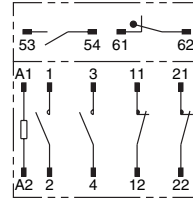

Note: The coil has no polarity.

G7Z-2A2B-02Z

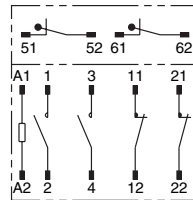

Note: The coil has no polarity.

### Auxiliary Contact Block

G73Z-20Z

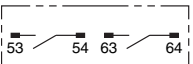

G73Z-11Z

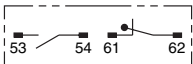

G73Z-02Z

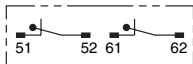

# Safety Precautions

Be sure to read the precautions “*Precautions for All Relays*” and “*Precautions for All Relays with Forcibly Guided Contacts*” in the website at:<http://www.ia.omron.com/>.

## Indication and Meaning for Safe Use

<b>! WARNING</b>	Indicates a potentially hazardous situation which, if not avoided, will result in minor or moderate injury, or may result in serious injury or death. Additionally there may be significant property damage.
<b>! CAUTION</b>	Indicates a potentially hazardous situation which, if not avoided, may result in minor or moderate injury or in property damage.
<b>Precautions for Correct Use</b>	Supplementary comments on what to do or avoid doing, to prevent failure to operate, or undesirable effect on product performance.

**! WARNING**

Take measures to prevent contact with charged parts when using the Relay for high voltages.

---

**! CAUTION**

Do not touch the terminal section (charged parts) when power is being supplied. Always use the Relay with terminal covers mounted. Contact with charged parts may result in electric shock.

Do not touch the Relay when power is being supplied or right after the power has been turned OFF. The hot surface may cause burn injury.

## Precautions for Correct Use

### Installation

- Mount the G7Z with the coil terminal at the top.

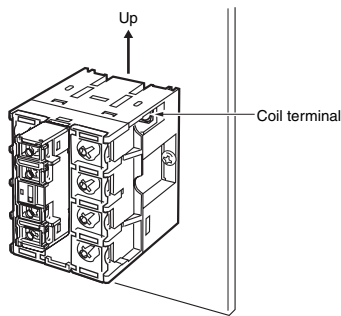

- Do not use the Relay with the terminal screw surfaces facing down.

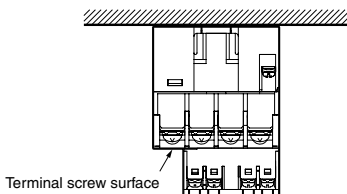

- To mount the Relay, secure M4 screws in two locations. Use a screw-tightening torque of 1.2 to 1.3 N-m.

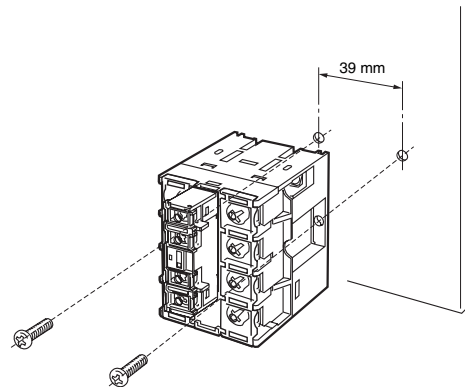

- The Relay can be mounted directly on a mounting rail (PFP) or a DIN Track (EN 50022-35 × 7.5, 15). The Relay cannot be mounted, however, to some reinforced rails (e.g., those produced by Kameda Denki or Toyogiken).
- Mount the Relay sideways when it is mounted on a rail.
- Use End Plates (PFP-M) on both sides of the Relay to make sure that it is properly secured.

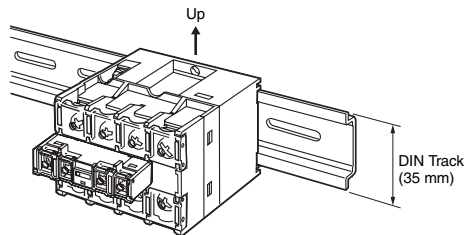

- Provide at least 5 mm of space between the sides and top of the Relay and nearby grounded metal surfaces.

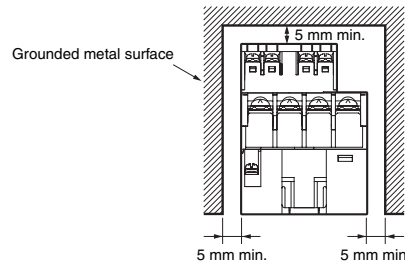

- Provide at least 30 mm of space between Relays when two or more Relays are mounted in a row.

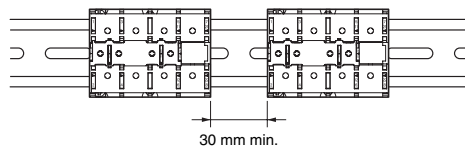

- The auxiliary contact block (G73Z) can be mounted on the Relay.

## Mounting and Removal

### Mounting

Insert the tab on the auxiliary contact block into the groove on the Relay and press down until the hook on the auxiliary contact block catches in the mounting hole on the Relay.

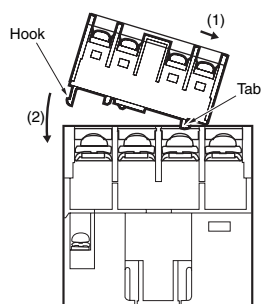

### Removing

Slide the auxiliary contact block, remove the auxiliary contact block tab from the groove on the Relay, and remove the auxiliary contact block hook from the Relay.

Be careful not to apply excessive force on the hook.

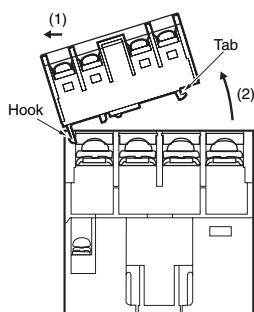

## Connecting

- Use round or open-end (Y-type) crimp terminals and connect the terminals with the appropriate tightening torque. Refer to the terminal section space in the following figure for the crimp terminal dimensions.

### Relay Contacts (Unit: mm)

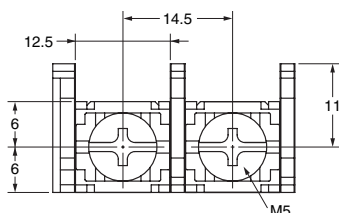

### Relay Coil

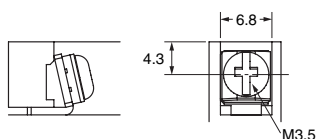

### Auxiliary Contact Block

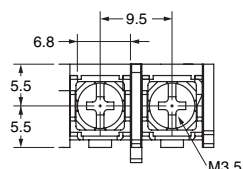

- One crimp terminal can be used for the Relay contact section (M5 screw). Two crimp terminals can be connected for the coil terminal and auxiliary contact block.

## Recommended Crimp Terminals and Wire

Location	Crimp terminals	Appropriate wire size
Contact section	5.5-5	2.63 to 6.64 mm <sup>2</sup> (AWG12, 10)
	8-5	6.64 to 10.52 mm <sup>2</sup> (AWG8)
Coil section	1.25-3.5	0.5 to 1.65 mm <sup>2</sup> (AWG20 to 16)

- Use the following tightening torque when tightening screws. Loose screws may result in fire caused by abnormal heat generated when the power is being supplied.
  - M5 screws: 2.0 to 2.2 N·m
  - M3.5 screws: 0.8 to 0.9 N·m
- Allow suitable slack on leads when wiring, and do not subject the terminals to excessive force.

## Microloads

The G7Z is used for switching power loads, such as current carry for device power supplies and heater loads. Use an auxiliary contact block (G73Z) if microloads are required for signal applications and operation status feedback.

## Coil

### (Internal Connections of Coils)

#### DC Coil



- If a transistor drives the G7Z, check the leakage current and connect a bleeder resistor if necessary.
- The must operate voltage is the minimum value for the Relay armature to operate and the contacts to turn ON. Therefore, fundamentally apply the rated voltage to the coils, taking into consideration the increases in coil resistance caused by voltage fluctuation and coil temperature rise.
- Counter-electromotive voltage generated by the coil when the coil is OFF may destroy semiconductor elements or cause malfunctions. Attach surge-absorbing diodes to both ends of the coil as a countermeasure. Particularly, when driving G7Z with semiconductor elements, always attach the surge-absorbing diodes.
 

Note that the relay reset time will be extended, so always use after verifying implementation under actual usage conditions.

Use surge-absorbing diodes with a minimum of 600 V reverse voltage resistance, and a forward current of approximately 1A. G7Z does not have coil polarity so attach surge-absorbing diodes so that the polarity is reverse to the applied voltage of the coil.

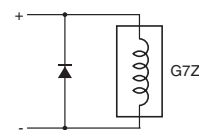

## Mirror Contact Mechanism

By combining a Relay with an auxiliary contact block, all NC contacts of the auxiliary contact block will satisfy an impulse withstand voltage of 2.5 kV or higher or maintain a gap of 0.5 mm or greater when the coil is de-energized even if at least one NO contact (main contact) of the Relay is welded.

### Description of Mirror Contact Mechanism

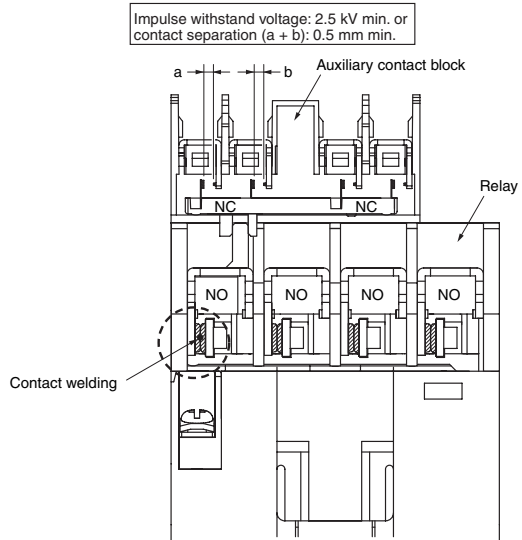



## Read and Understand This Catalog

Please read and understand this catalog before purchasing the products. Please consult your OMRON representative if you have any questions or comments.

## Warranty and Limitations of Liability

### WARRANTY

OMRON's exclusive warranty is that the products are free from defects in materials and workmanship for a period of one year (or other period if specified) from date of sale by OMRON.

OMRON MAKES NO WARRANTY OR REPRESENTATION, EXPRESS OR IMPLIED, REGARDING NON-INFRINGEMENT, MERCHANTABILITY, OR FITNESS FOR PARTICULAR PURPOSE OF THE PRODUCTS. ANY BUYER OR USER ACKNOWLEDGES THAT THE BUYER OR USER ALONE HAS DETERMINED THAT THE PRODUCTS WILL SUITABLY MEET THE REQUIREMENTS OF THEIR INTENDED USE. OMRON DISCLAIMS ALL OTHER WARRANTIES, EXPRESS OR IMPLIED.

### LIMITATIONS OF LIABILITY

OMRON SHALL NOT BE RESPONSIBLE FOR SPECIAL, INDIRECT, OR CONSEQUENTIAL DAMAGES, LOSS OF PROFITS OR COMMERCIAL LOSS IN ANY WAY CONNECTED WITH THE PRODUCTS, WHETHER SUCH CLAIM IS BASED ON CONTRACT, WARRANTY, NEGLIGENCE, OR STRICT LIABILITY.

In no event shall the responsibility of OMRON for any act exceed the individual price of the product on which liability is asserted.

IN NO EVENT SHALL OMRON BE RESPONSIBLE FOR WARRANTY, REPAIR, OR OTHER CLAIMS REGARDING THE PRODUCTS UNLESS OMRON'S ANALYSIS CONFIRMS THAT THE PRODUCTS WERE PROPERLY HANDLED, STORED, INSTALLED, AND MAINTAINED AND NOT SUBJECT TO CONTAMINATION, ABUSE, MISUSE, OR INAPPROPRIATE MODIFICATION OR REPAIR.

## Application Considerations

### SUITABILITY FOR USE

OMRON shall not be responsible for conformity with any standards, codes, or regulations that apply to the combination of products in the customer's application or use of the products.

At the customer's request, OMRON will provide applicable third party certification documents identifying ratings and limitations of use that apply to the products. This information by itself is not sufficient for a complete determination of the suitability of the products in combination with the end product, machine, system, or other application or use.

The following are some examples of applications for which particular attention must be given. This is not intended to be an exhaustive list of all possible uses of the products, nor is it intended to imply that the uses listed may be suitable for the products:

- Outdoor use, uses involving potential chemical contamination or electrical interference, or conditions or uses not described in this catalog.
- Nuclear energy control systems, combustion systems, railroad systems, aviation systems, medical equipment, amusement machines, vehicles, safety equipment, and installations subject to separate industry or government regulations.
- Systems, machines, and equipment that could present a risk to life or property.

Please know and observe all prohibitions of use applicable to the products.

NEVER USE THE PRODUCTS FOR AN APPLICATION INVOLVING SERIOUS RISK TO LIFE OR PROPERTY WITHOUT ENSURING THAT THE SYSTEM AS A WHOLE HAS BEEN DESIGNED TO ADDRESS THE RISKS, AND THAT THE OMRON PRODUCTS ARE PROPERLY RATED AND INSTALLED FOR THE INTENDED USE WITHIN THE OVERALL EQUIPMENT OR SYSTEM.

### PROGRAMMABLE PRODUCTS

OMRON shall not be responsible for the user's programming of a programmable product, or any consequence thereof.

## Disclaimers

### CHANGE IN SPECIFICATIONS

Product specifications and accessories may be changed at any time based on improvements and other reasons.

It is our practice to change model numbers when published ratings or features are changed, or when significant construction changes are made. However, some specifications of the products may be changed without any notice. When in doubt, special model numbers may be assigned to fix or establish key specifications for your application on your request. Please consult with your OMRON representative at any time to confirm actual specifications of purchased products.

### DIMENSIONS AND WEIGHTS

Dimensions and weights are nominal and are not to be used for manufacturing purposes, even when tolerances are shown.

### PERFORMANCE DATA

Performance data given in this catalog is provided as a guide for the user in determining suitability and does not constitute a warranty. It may represent the result of OMRON's test conditions, and the users must correlate it to actual application requirements. Actual performance is subject to the OMRON Warranty and Limitations of Liability.

### ERRORS AND OMISSIONS

The information in this document has been carefully checked and is believed to be accurate; however, no responsibility is assumed for clerical, typographical, or proofreading errors, or omissions.

2012.9

In the interest of product improvement, specifications are subject to change without notice.

**OMRON Corporation**  
Industrial Automation Company

<http://www.ia.omron.com/>

(c)Copyright OMRON Corporation 2012 All Right Reserved.